

Vent-Axia®

Uniflex plus +

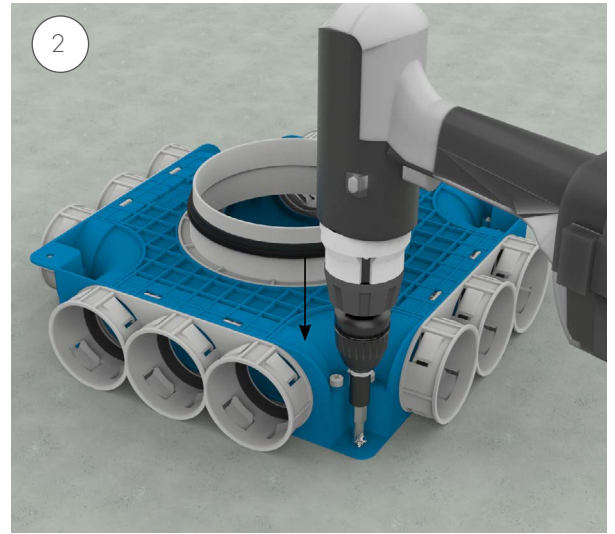

Ø160

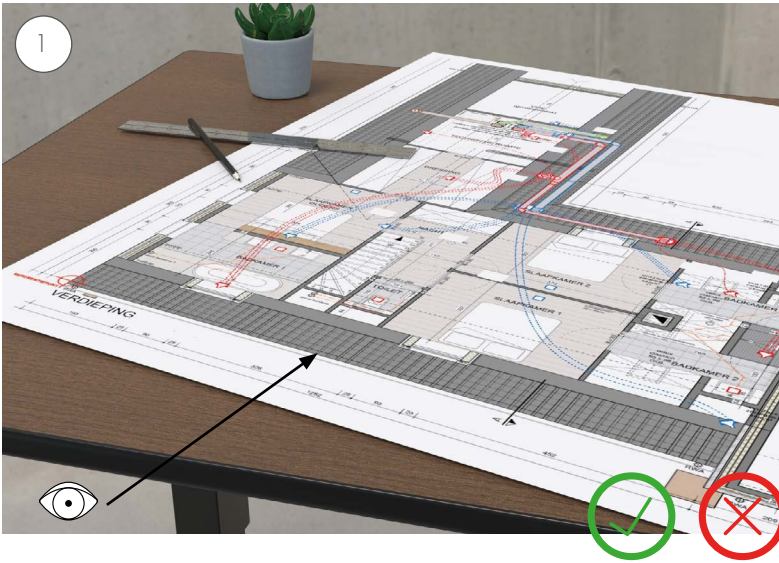
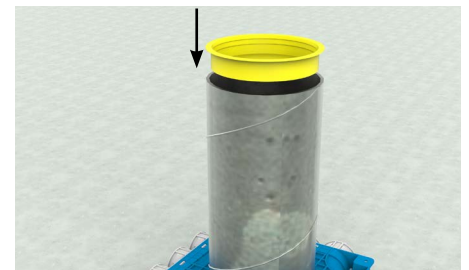
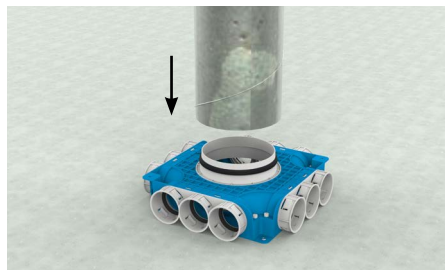

Ø125 / Ø180

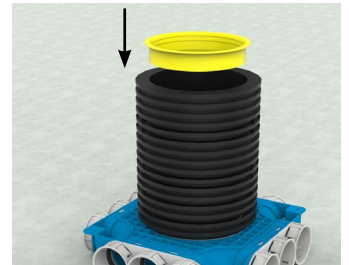
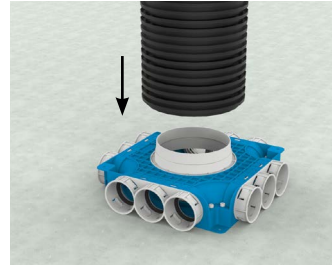
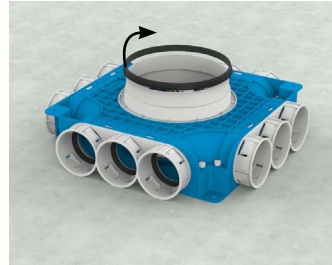

Ø160

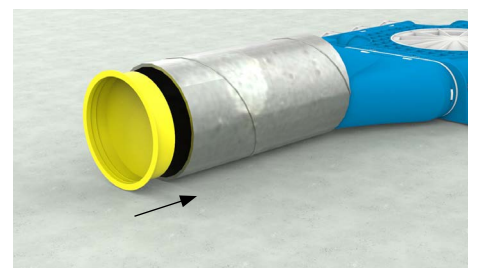
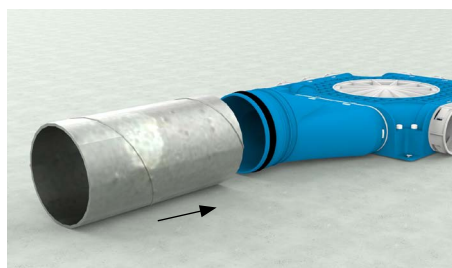
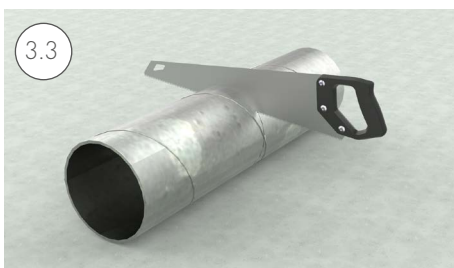

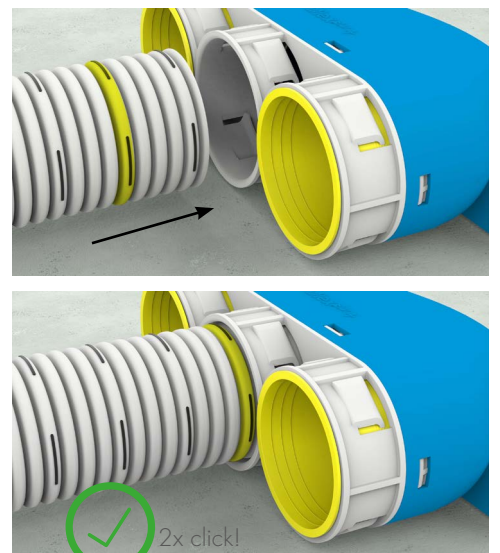
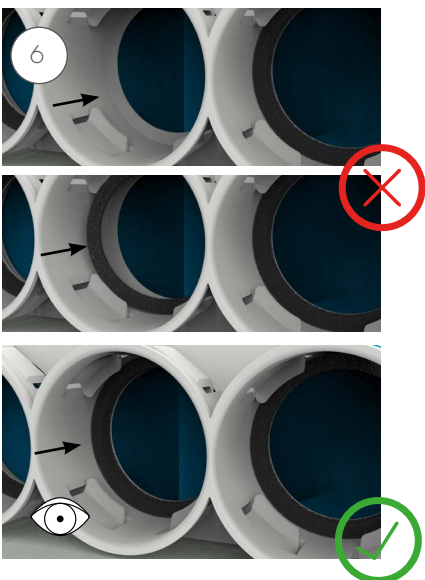
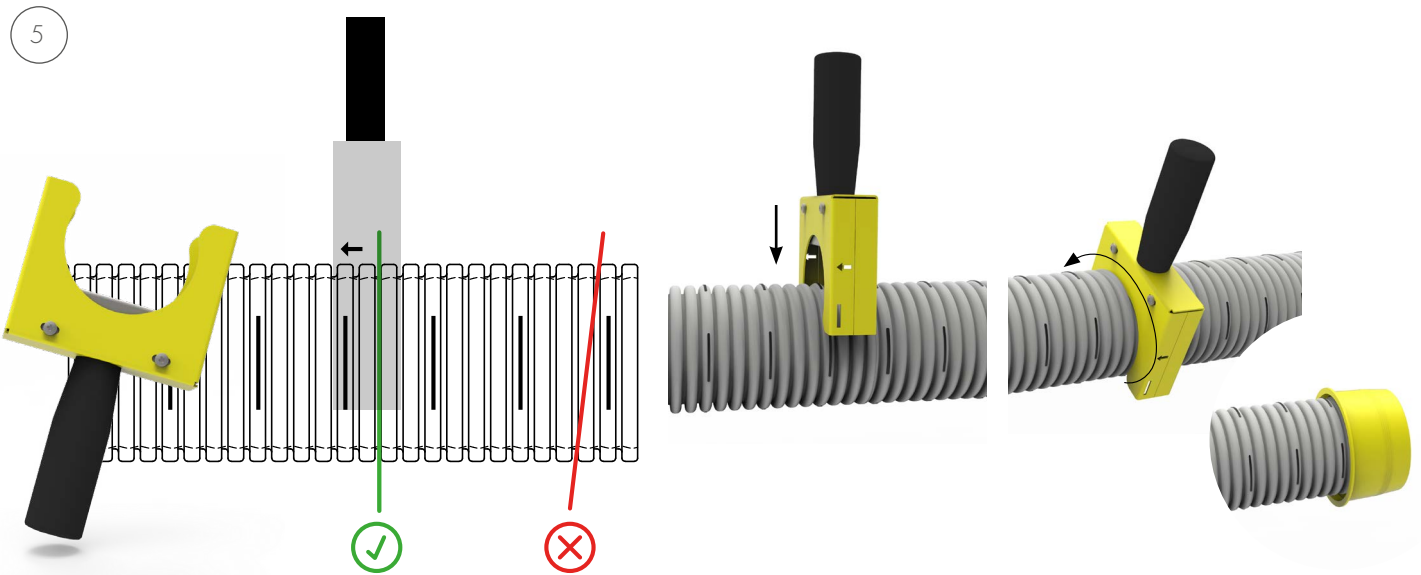
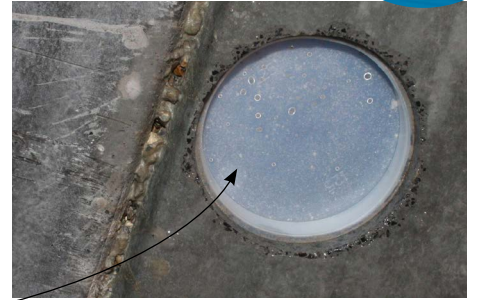
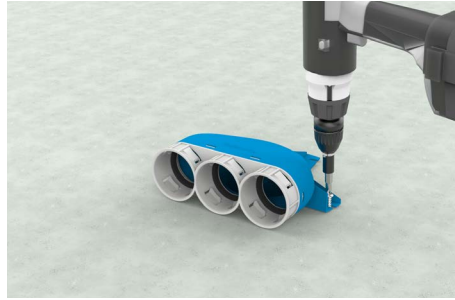
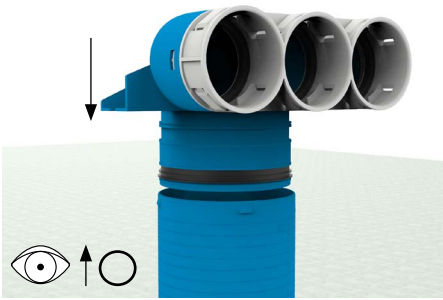
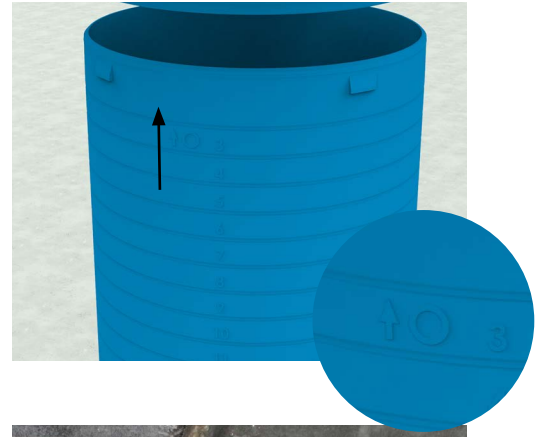
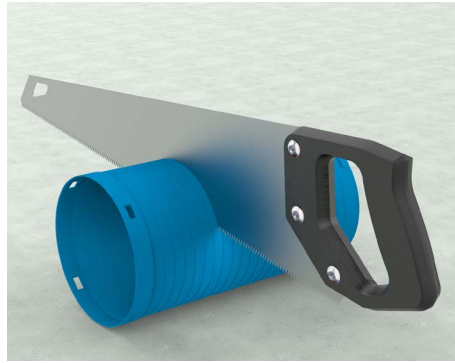
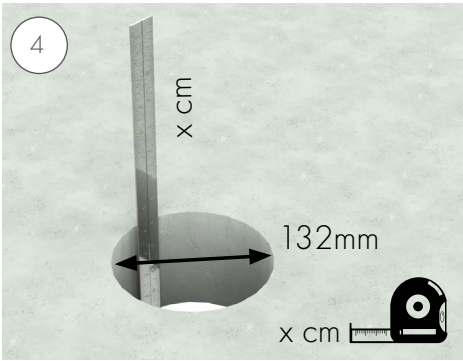

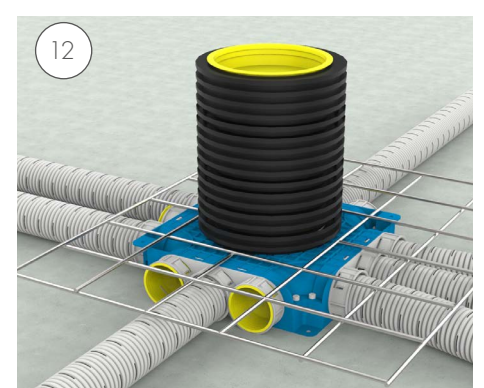
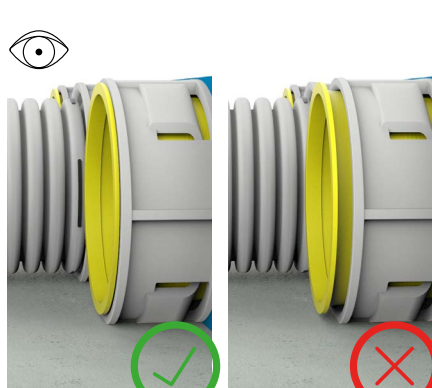
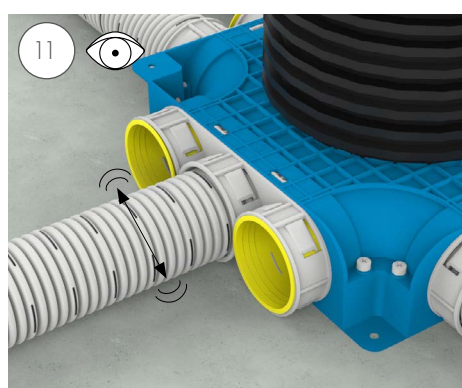
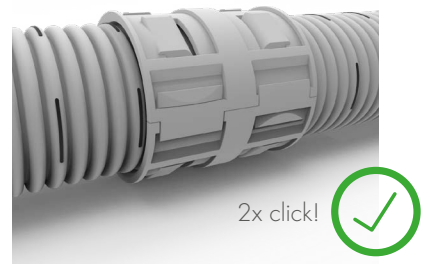
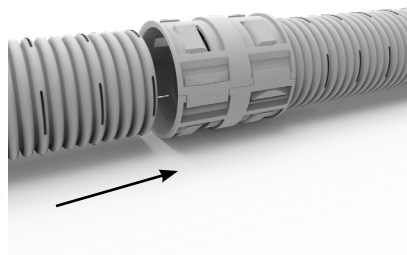
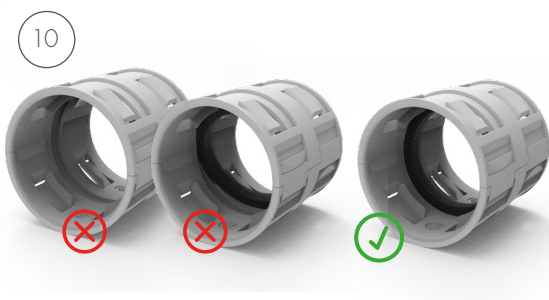
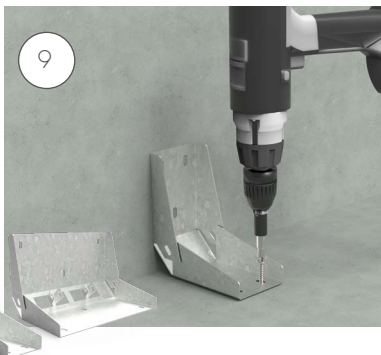
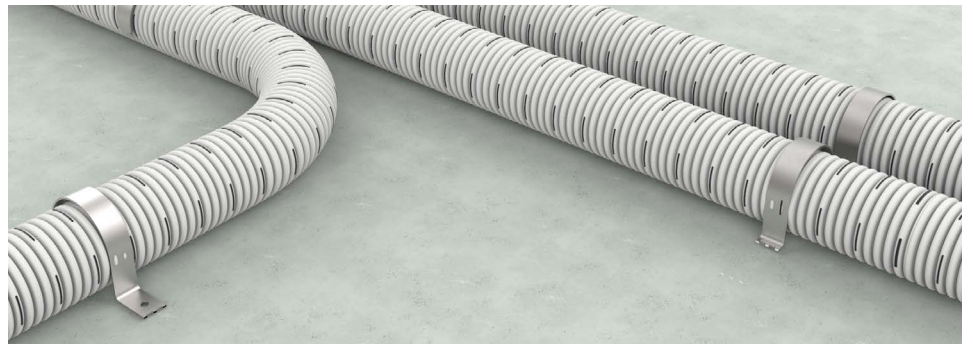
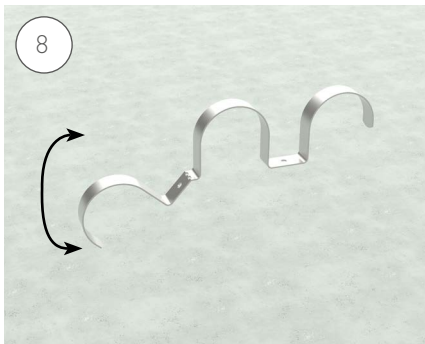
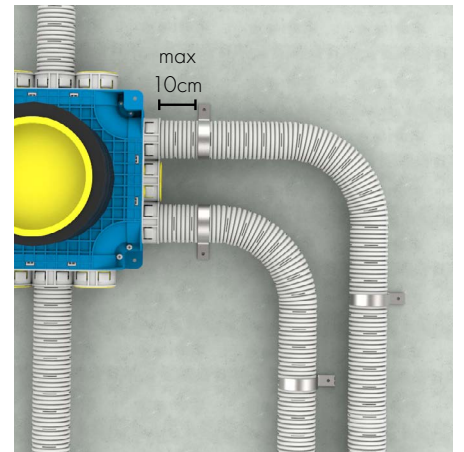
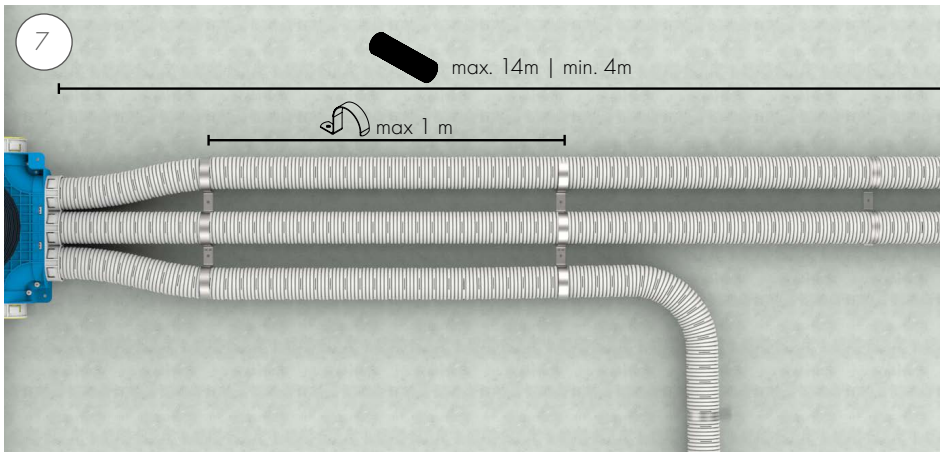



EN This product contains an approved biocide (silver ions encapsulated in a ceramic material - Sanitized MBE99-58) to minimize bacterial formation;
 NL Dit product bevat een goedgekeurd biocide (Zilverionen ingekapseld in keramisch materiaal - Sanitized MBE99-58) om bacterievorming tot een minimum te beperken;
 DE Dieses Produkt enthält ein zugelassenes Biocid (Silberionen in einem Keramikmaterial

eingekapselt - Sanitized MBE99-58), um die Bildung von Bakterien zu minimieren;
 FR Ce produit contient un biocide approuvé (ions d'argent encapsulés dans un matériau céramique - Sanitized MBE99-58) pour minimiser la formation bactérienne;
 DK Dette produkt indeholder et godkendt biocid (sølvrioner indkapslet i keramisk materiale - Sanitized MBE99-58) for at minimere bakteriedannelse;

PL Ten produkt zawiera zatwierdzony środek biobójczy (jony srebra zamknięte w materiale ceramicznym - Sanitized MBE99-58), aby zminimalizować tworzenie się bakterii;
 IT Questo prodotto contiene un biocida approvato (ioni d'argento incapsulati in un materiale ceramico - Sanitized MBE99-58) per ridurre al minimo la formazione di batteri.
 I.a.w. Biocidal Products Regulation (EU 528/2012)