

**CARATTERISTICHE:**

Diffusori circolari a geometria fissa ed effetto elicoidale.

**COSTRUZIONE:**

Acciaio verniciato bianco RAL 9010.

**IMPIEGO:**

A soffitto, in mandata e ripresa.

Altezza di installazione: 2,8-4,6 m.

**FISSAGGIO:**

Fissaggio mediante viti sul collo del diffusore.

**ACCESSORI:**

Plenum di raccordo in acciaio zincato con isolamento e serranda di taratura.

**CHARACTERISTICS:**

Fixed geometry circular diffusers with helical-effect.

**CONSTRUCTION:**

RAL 9010 white painted steel.

**UTILIZATION:**

For ceiling installation and for air intake and delivery.

Installation height: 2,8-4,6 m.

**FIXING:**





Fixing by screws on neck diffuser.

**ACCESSORIES:**

Galvanized steel connecting plenum with insulation and calibration damper.

**PREZZI - PRICES**

■ STOCK

					Serranda per plenum Damper for plenum	Equalizzatore per plenum Equalizer for plenum
	DEE	DEEP 595x595 mm	PDC	PDCI		
mm	€	€	€	€	€	€
100						
125						
160						
200						
250						
315						
400						

**DESCRIZIONI - DESCRIPTION:**

**DEE:** Diffusore circolare ad effetto elicoidale con pale fisse - Fixed geometry swirl diffuser

**DEEP:** Diffusore circolare ad effetto elicoidale con pale fisse su pannello 595x595 - Fixed geometry swirl diffuser on panel 595x595

**MISURE - MEASURES**

Dimensioni nominali Ø mm Nominal dimensions Ø mm	DEE			PLENUM PDC mm		
	ØA	ØB	H	AxA	ØD	ØE
100	152	98	66	200x200	96	102
125	201	123	66	200x200	96	127
160	252	158	66	250x250	156	162
200	302	198	66	300x300	156	202
250	352	248	66	350x350	196	252
315	452	313	90	400x400	246	317
400	550	398	120	500x500	311	402

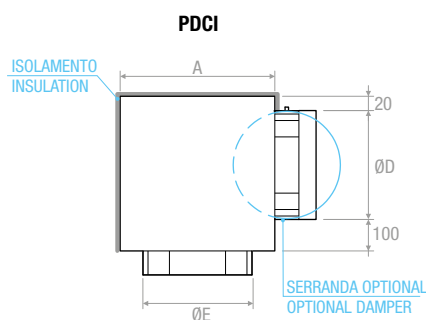
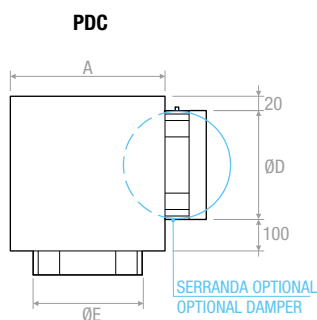
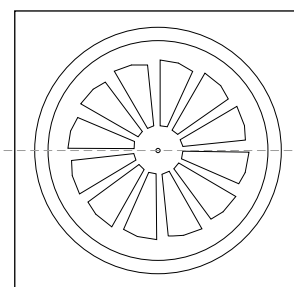
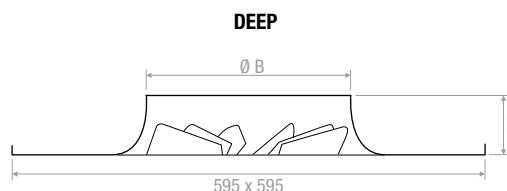
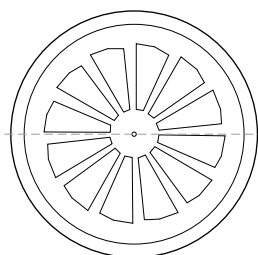
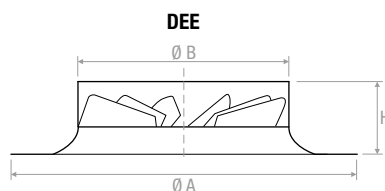
**DISEGNI - DRAWINGS**

## DIAGRAMMA SCELTA RAPIDA - QUICK SELECTION DIAGRAM

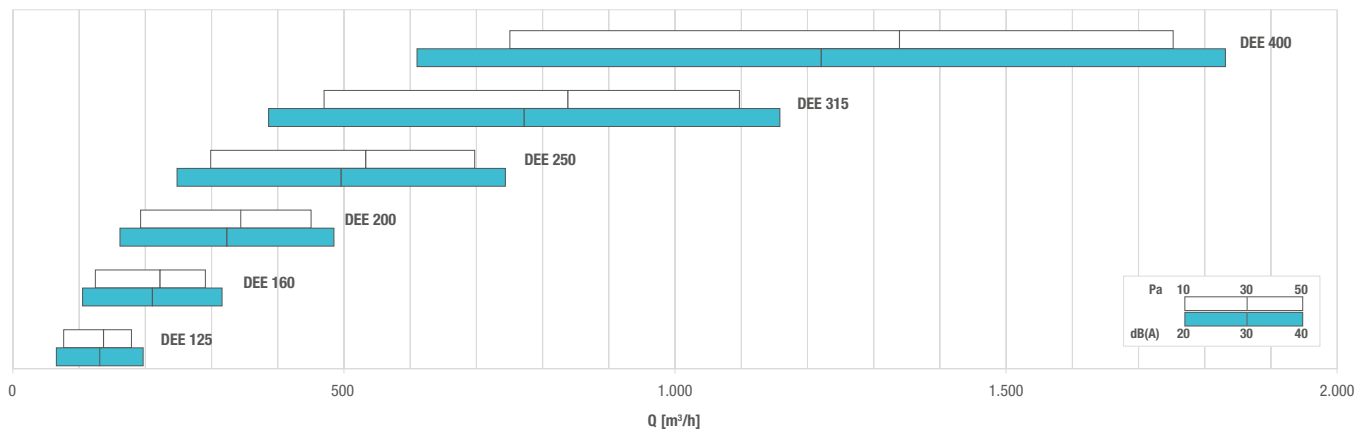

## TABELLA DI SELEZIONE - SELECTION TABLE

Modello - Model	A <sub>x</sub> [m²]	Q [m³/h]		L <sub>wa</sub> [dB(A)]		X <sub>(0,25)</sub> [m]		Dp <sub>t</sub> * [Pa]	
		min	max	min	max	min	max	min	max
<b>DEE 125</b>	0,00912	80	180	22	37	0,36	0,81	10	50
<b>DEE 160</b>	0,01464	120	290	21	38	0,46	1,13	10	50
<b>DEE 200</b>	0,02245	190	450	22	38	0,63	1,50	10	50
<b>DEE 250</b>	0,03444	300	700	22	38	0,85	1,98	10	50
<b>DEE 315</b>	0,05364	470	1100	22	38	1,11	2,60	10	50
<b>DEE 400</b>	0,08479	750	1750	22	39	1,46	3,41	10	50