

CARATTERISTICHE:

Griglie pedonabili a barre fisse orizzontali passo 12,5 mm con cornice.

COSTRUZIONE:

Alluminio anodizzato.

IMPIEGO:

A pavimento, in mandata o ripresa.

FISSAGGIO:

Fissaggio con viti.

ACCESSORI:

- Serranda di taratura in acciaio zincato con alette a movimento contrapposto.

CHARACTERISTICS:

Floor grilles composed BY horizontal fixed bars with 12,5 mm pitch, with frame.

CONSTRUCTION:

Anodized aluminium.

UTILIZATION:

For floor installation and for air intake or delivery.



FIXING:

Fixing by using screws.

ACCESSORIES:

- Calibration damper made of galvanized steel and fins with opposite movement.

PREZZI - PRICES

		
BxH	GRPZ	SCZ
mm	€	€
300x100		
400x100		
500x100		
600x100		
800x100		
1000x100		
300x150		
400x150		
500x150		
600x150		
800x150		
1000x150		
400x200		
500x200		
600x200		
800x200		
1000x200		
500x300		
600x300		
800x300		
1000x300		
600x400		
800x400		
1000x400		
600x500		
800x500		
1000x500		
600x600		
800x600		
1000x600		

ACCESSORI - ACCESSORIES:

SCZ: Serranda di taratura ad alette con movimento contrapposto - Opposed blade damper

DISEGNI - DRAWINGS



DIAGRAMMA SCELTA RAPIDA - QUICK SELECTION DIAGRAM

GRI

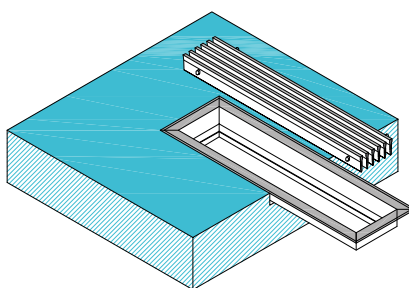
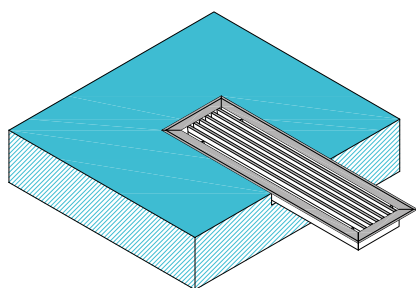
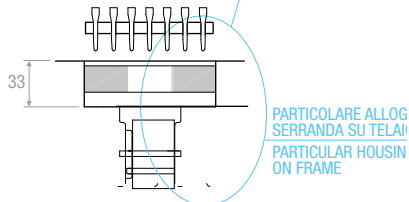
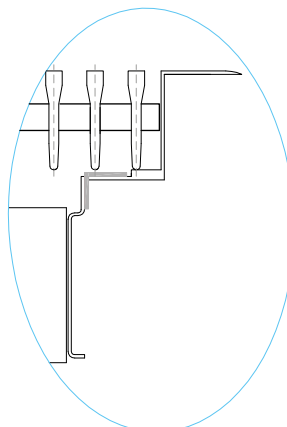
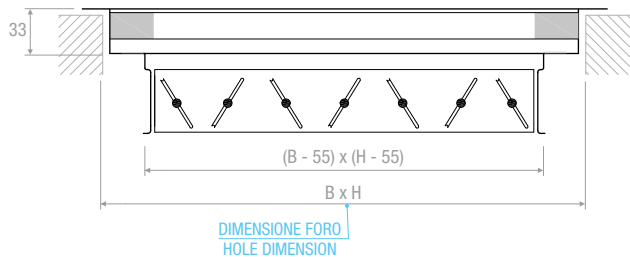
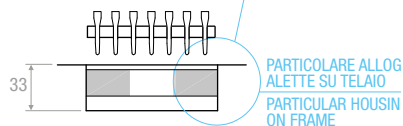
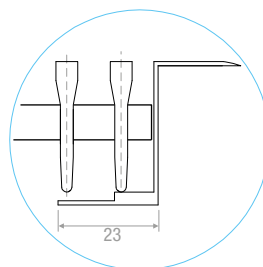
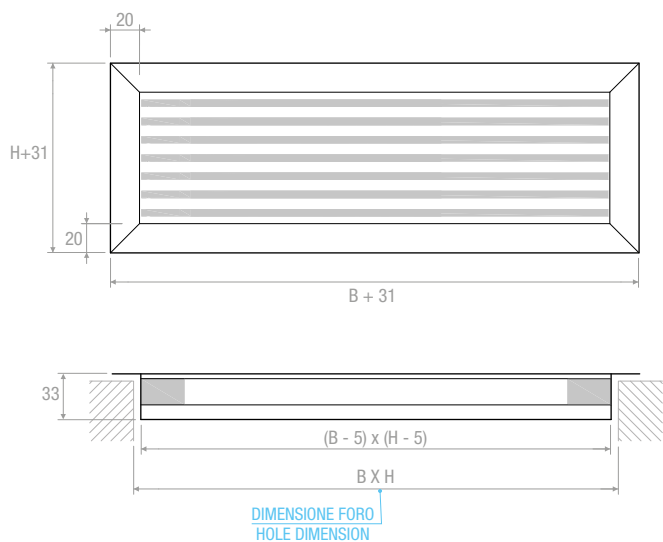

TABELLA DI SELEZIONE - SELECTION TABLE

Modello - Model	A _s [m ²]	Q [m ³ /h]		L _{WA} [dB(A)]		Y (0,25) [m]		Dp, [Pa]	
		min	max	min	max	min	max	min	max
GRPZ 300x100	0,0126	120	240	21	38	2,2	4,9	5	20
GRPZ 400x100	0,0172	160	330	22	40	2,6	5,9	5	20
GRPZ 500x100	0,0220	210	420	24	41	3,2	6,7	5	20
GRPZ 600x100	0,0268	250	510	25	42	3,5	7,4	5	20
GRPZ 800x100	0,0368	350	700	27	44	4,2	8,8	5	20
GRPZ 1000x100	0,0470	450	900	28	45	4,9	10,0	5	20
GRPZ 300x150	0,0196	190	370	24	40	3,1	6,3	5	20
GRPZ 400x150	0,0268	250	510	25	42	3,5	7,6	5	20
GRPZ 500x150	0,0343	320	650	26	43	4,1	8,6	5	20
GRPZ 600x150	0,0418	400	800	28	44	4,7	9,6	5	20
GRPZ 800x150	0,0573	540	1100	29	46	5,4	11,3	5	20
GRPZ 1000x150	0,0732	690	1400	30	47	6,2	12,7	5	20
GRPZ 400x200	0,0368	350	700	27	44	4,4	9,1	5	20
GRPZ 500x200	0,0470	450	900	28	45	5,0	10,3	5	20
GRPZ 600x200	0,0573	540	1100	29	46	5,5	11,4	5	20
GRPZ 800x200	0,0785	740	1500	30	48	6,5	13,3	5	20
GRPZ 1000x200	0,1003	950	1920	32	49	7,4	15,1	5	20
GRPZ 500x300	0,0732	690	1400	30	47	6,4	13,1	5	20
GRPZ 600x300	0,0893	850	1710	31	48	7,1	14,5	5	20
GRPZ 800x300	0,1224	1160	2340	33	50	8,3	16,9	5	20
GRPZ 1000x300	0,1563	1480	2990	34	51	9,4	19,1	5	20
GRPZ 600x400	0,1224	1160	2340	33	50	8,4	17,1	5	20
GRPZ 800x400	0,1677	1590	3200	34	51	9,8	20,0	5	20
GRPZ 1000x400	0,2141	2030	4090	36	53	11,1	22,5	5	20
GRPZ 600x500	0,1563	1480	2990	34	51	9,6	19,5	5	20
GRPZ 800x500	0,2141	2030	4090	36	53	11,2	22,7	5	20
GRPZ 1000x500	0,2733	2590	5220	37	54	12,6	25,6	5	20
GRPZ 600x600	0,1908	1810	3650	35	52	10,7	21,7	5	20
GRPZ 800x600	0,2613	2480	5000	37	54	12,5	25,3	5	20
GRPZ 1000x600	0,3336	3160	6380	38	55	14,0	28,5	5	20

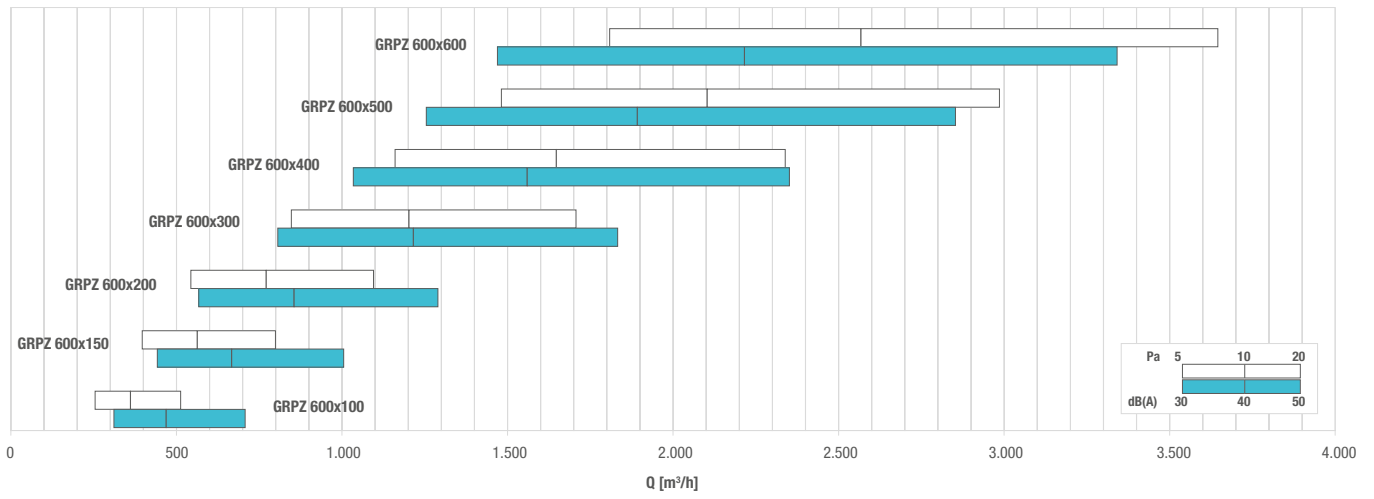